



T12D

Instruction Manual



12 Fully-proportional Channels Transmitter

Contents

Chapter 1 T12D Remote Control System	3
1.1 Safety Precautions	3
1.2 T12D Introduction	3
1.2.1 Specifications	3
1.2.2 Packing List	6
1.2.3 T12D Overview	6
1.2.4 Transmitter Basic Operation	8
1.2.5 Power on T12D	8
1.2.6 Language Select	9
1.2.7 Transmitter Low Voltage Alarm	9
1.3 R16F Introduction	10
1.3.1 Features of R16F	10
1.3.2 Binding	11
1.3.3 Receiver Connection	11
1.3.4 Working Modes	12
1.3.5 Receiver Firmware Update	14
1.3.6 Installment of Receiver Antenna	15
1.3.7 RSSI Testing	15
Chapter 2 General Settings	16
2.1 MONITOR	16
2.2 REVERSE	17
2.3 END POINTS	17
2.4 CH SPEED	17
2.5 AUX CH	18
2.6 TRIMS	18
2.7 PROG.MIX	18
Chapter 3 Advanced Settings	19
3.1 TYPE SELECT	20
3.2 FLIGHT MODE	20
3.3 CONDITION	21
3.4 RATE/CURVE	21
3.5 THROTTLE CURVE	22
3.6 THROTTLE HOLD	23

3.7 V_TAIL (Fixed-wing)	23
3.8 DELTA-WING MIX (Delta-wing)	24
3.9 GYROSCOPE	24
3.10 PITCH CURVE (Helicopter)	24
3.11 HELICOPTER SETTINGS (Helicopter)	24
3.12 TRACK MIX	25
Chapter 4 Transmitter Settings	25
4.1 MODEL	25
4.1.1 Model Select	26
4.1.2 Model Type	26
4.1.3 Model Copy/Paste	26
4.1.4 Model Rename	26
4.1.5 Model Reset	26
4.2 SYSTEM SETTING	26
4.3 STICK MODE	28
4.4 TRAINER	30
4.5 TIMER	30
4.6 SWITCH SETTING	31
4.7 BOOT SETTINGS	32
4.8 ABOUT	32
Chapter 5 Receiver Settings	33
5.1 RF SETTINGS	33
5.2 SUBSIDIARY ID	33
5.3 SENSOR	34
5.4 FAILSAFE	35
5.5 EXT RF SETTINGS	35
Chapter 6 Firmware Update	36

Chapter 1 T12D Remote Control System

1.1 Safety Precautions

1. Do not operate outdoors on rainy days, run through puddles of water, or use when visibility is limited. Should any type of moisture (water or snow) enter any component of the system, erratic operation and loss of control may occur.
2. Do not operate in the places that near people or roads.
3. This product is not a toy and is NOT suitable for children under the age of 14. Adults should keep the product out of the reach of children and exercise caution when operating this product in the presence of children.
4. Please strictly abide by local laws and regulations when flying to ensure safe flight!
5. Make sure the throttle stick and trim button are set at the lowest end before turning on. Then turn on the transmitter and check whether the power supply is sufficient, and turn on the receiver!
6. Check whether the various actions of servo are consistent with the direction of the corresponding joystick before operating the model. If they are inconsistent, please adjust before using!
7. Please turn off the power supply of the receiver and controlled equipment first, and then turn off the transmitter. If the operation is reversed, it may cause loss of control and cause an accident!

1.2 T12D Introduction

1.2.1 Specifications

T12D Transmitter	
Dimension	174.3*206.9*106.9mm(6.86"*8.15"*4.21")
Battery Case Dimension	114.4*35.4*32mm(4.5"*1.39"*1.26")
Antenna Length	90mm(3.54")
Weight	536g(18.9oz)
Channels	12 fully proportional channels, 5-12 channels can be programmed
Output Frequency	2.4GHz ISM band(2400MHz~2483.5MHz)
Spread Spectrum	FHSS 67 channels pseudo-random frequency hopping
Signal Output	PWM&SBUS&PPM&CRSF
Operating Systems	freeRTOS+LVGL GUI
Long-range Module	It fully supports ELRS, TBS Crossfire, and other mainstream long-range modules
Menu Customized	Setting Menu, font, desktop, system theme, etc., can be customized

Response Latency	3ms, 4ms, 14ms can be selected
Channel Resolution	4096 with regular jitter of 0.5us
Modulation Mode	GFSK
Channel Band Width	400KHz
Channel Pacing	1200KHz
Transmitter Power	<100mW(20dBm)
Adjacent Channel Rejection	>36dBm
Transmission Rate	38kbps
Reception Sensitivity	-104dBm
PWM Output Range	1.0ms~2.0ms
Cycle	15ms/per frame
Operating Voltage	7.4-18.0V(8pcs AA battery, a 2S-4S LiPo or 18650 Lithium battery. When external module is connected, please make sure the power supply voltage cannot exceed the working voltage of the module)
Type-C Port Voltage and Current	Input Voltage: 5V(T12D also can be powered by computer or mobile power bank via Type-C cable) Input Current: 500mA Output Voltage: 4.6V-5.0V Output Current: Maximum 1A
Operating Current	100mA(\pm 10mA)@8.4V DC
Control Distance	①Internal RF: 4000 meters in the air(Maximum range is tested in an unobstructed area free of interference) ②External RF: Depends on the RX and TX of the long-range module
Adaptable Models	Rotary Wing/Fixed-wing/Glider/Multicopter/Car/Boat/Robot
Low Voltage Alarm	Low transmitter voltage, low receiver voltage, low model battery voltage, or low RSSI alarm can be customized
Storage Model Quantity	100
Subsidiary ID Quantity	15
Simulator Mode	Yes

Trainer Function	Support
Screen	2.8 inches 16 colorful screens, 320*240 pixels
Compatible Receivers	R16F(Std), R8EF, R8FM, R8SM, R8XM, R8FGH, R8FG, R7FG, R6FG, R6F, R4FGM, R4F
Operating Temperature	-30° to 85° C
Compatible Control Board Hardware Models	Ardupilot, pix4, beta, Arduino, and Raspberry Pi, can be connected with SBUS signal

R16F Receiver	
Dimension	45*32*15mm(1.77"*1.26"*0.59")
Weight	17g (0.6")
Channel	16 channels
Operating Voltage	3~12V
Operating Current	50±10mA@5V
Antenna Length	205mm (8.07")
Signal Output	SBUS+CRSF+PWM
Output Frequency	2.4GHz ISM band(2400MHz~2483.5MHz)
Spread Spectrum	FHSS 67 channels pseudo-random frequency hopping
Adaptable Models	Rotary Wing/Fixed-wing/Glider/Multicopter/Car/Boat/Robot
Control Distance	4000 meters in the air(Maximum range is tested in an unobstructed area free of interference)
Telemetry	Real-time built-in telemetry of the model battery voltage, RSSI, and receiver voltage. R16F has built-in data transmission functions. When connected to the flight control, they can send back information such as latitude and longitude, distance, number of satellites, heading, and other information in real-time.
Upgrade Online	with a Type-C cable (for data transmission) connecting the R16F to the computer, the latest cutting-edge functions can be easily added without any extra device.
EXT Battery Input	1S-8S(3.0-33.6V)
Response Latency	3ms, 4ms, 14ms can be selected

Water Splash Proof	The waterproof grade is IPX4
Operating Temperature	-30° to 85° C
Compatible transmitter	T16D/T12D/T8FB/T8S/RC8X/RC6GS V3/RC4GS V3/RC6GS V2/RC4GS V2/RC6GS/RC4GS

1.2.2 Packing List



T12D Transmitter×1



R16F Receiver×1



Type-C Cable×1



Hook and Spring×1



Instruction Manual×1



Packing Box×1

1.2.3 T12D Overview

Take Mode 2 as an example:



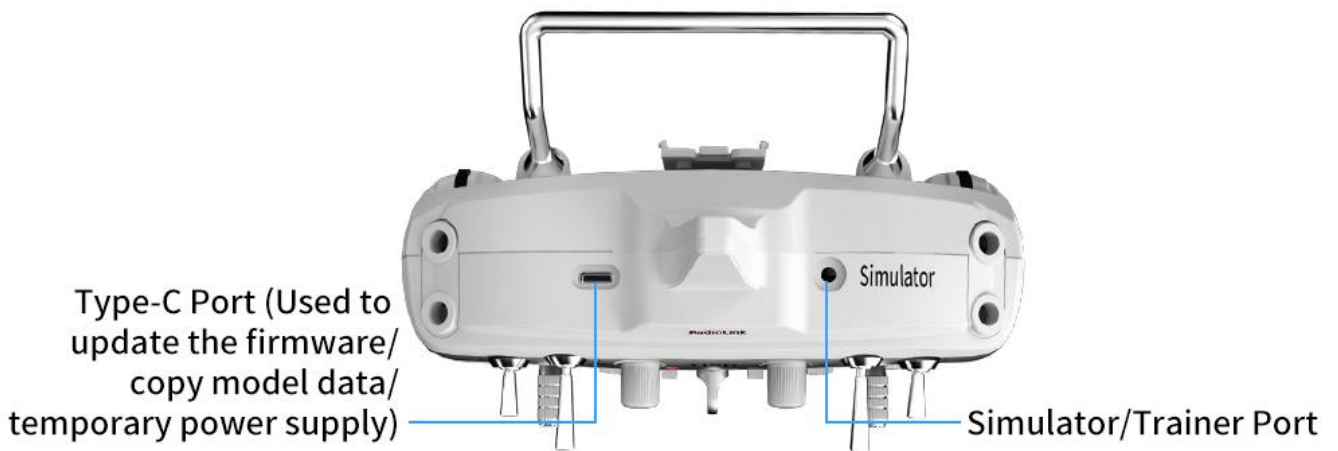
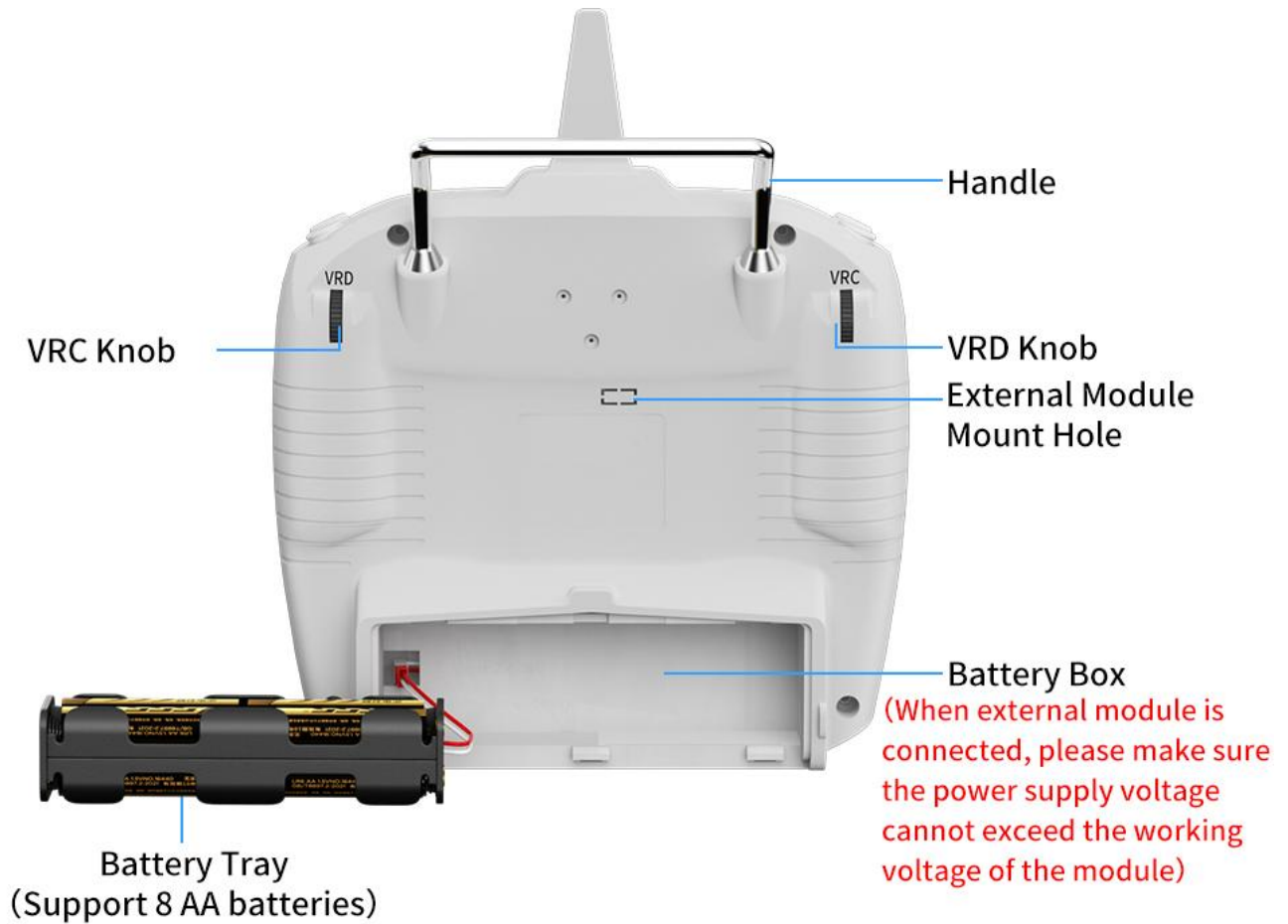

Note:

1. If the external module is selected in Receiver settings--RF SETTINGS, the green RF LED is off.
2. The type-C port of T12D can be used to update the firmware, copy model data and temporarily supply power to T12D. When the battery is dead, you can connect the power supply device such as a mobile power bank or a computer to the USB Type-C port to supply 5V power to T12D, and then long press home button to power on T12D. The maximum input voltage of the Type-C port of T12D is 5V.

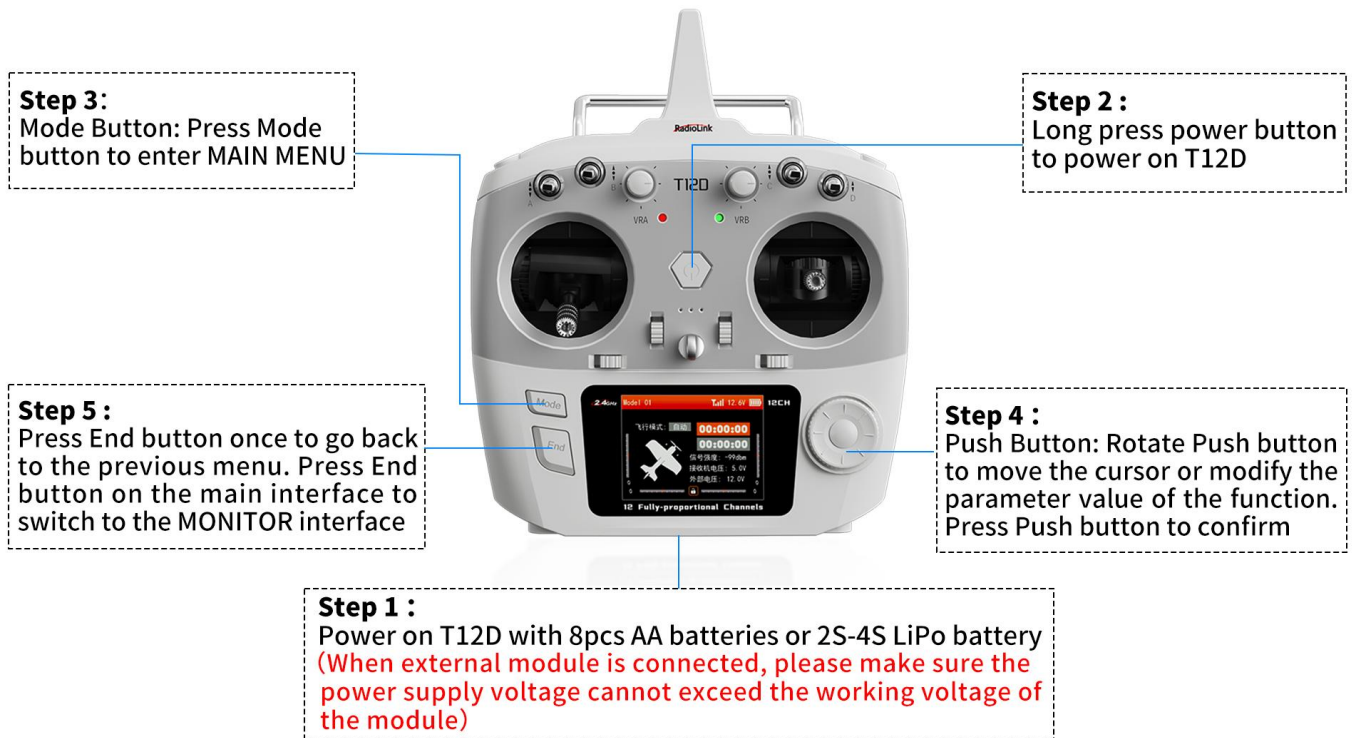

1.2.4 Transmitter Basic Operation

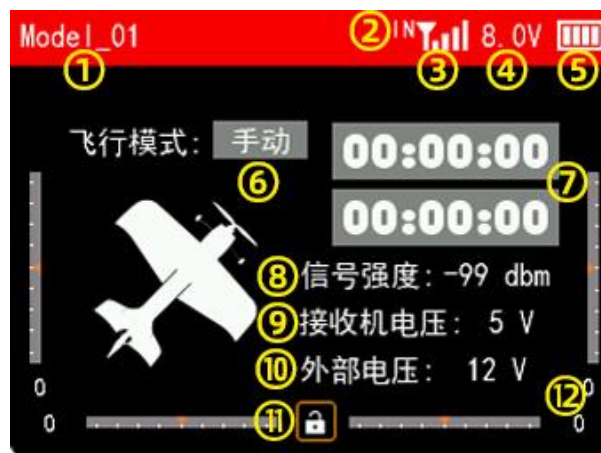

1.2.5 Power on T12D



Long pressing the power button of T12D to turn it on, the screen will display as shown below:

- ① The name of the current model. You can select different models in Transmitter Settings - MODEL interface. T12D can support up to 20 sets of model storage. Before operating the model, be sure to check whether the model on the screen is consistent with the actual model used. If you select the wrong model, the movement, direction and neutral position settings of the servo will be wrong. Operating the remote control at this time may cause damage to the model.
- ② Module selection. It can be set in Receiver settings--RF SETTINGS interface. When internal module is selected, IN is displayed here ; when external module is selected, EX is displayed here .
- ③  Signal tower logo. After the transmitter and receiver are successfully bound, the signal tower will be displayed on the screen of T12D. This logo can show the signal strength between the transmitter and the receiver.

- ④ Battery voltage of the transmitter.
- ⑤ Current power display.
- ⑥ Current flight mode.
- ⑦ Timer 1 and Timer 2. Move the cursor to timer 1 or timer 2, short press the Push button to start or stop timing, and long press the Push button to reset.
- ⑧ Received Signal Strength Indication. "NULL" means there is no signal or the receiver and transmitter have not been successfully bound. The closer the RSSI value is to 0, the stronger the signal. The larger the negative RSSI value, the weaker the signal.
- ⑨ The power supply voltage of the receiver;
- ⑩ Power battery voltage on the model. When using a receiver with a telemetry function and the telemetry cable is correctly connected, the external voltage will be displayed on the screen of the transmitter.
- ⑪ Screen lock. Move the cursor to the lock and long press the Push button to lock or unlock the screen. When the screen is locked, the lock is red. At this time, the Push or Mode button will not work, but you can short press the End button to quickly view the monitor interface. Long press Push button to unlock the screen, the lock will turn white, and all button functions will be restored.
- ⑫ Take mode 2 as an example. There are four scale marks on the bottom and left and right edges of the screen. When controlling a fixed-wing model, these scale marks represent the trim of aileron, elevator, throttle and rudder respectively, corresponding to the four trim levers on the transmitter (refer to 1.2.3 Overview). Be careful not to use this trim when debugging the model before its first flight. This trim is suitable for fine-tuning the attitude of the model when it is flying horizontally during its first operation.

1.2.6 Language Select

The menu interface is available in multiple languages, including Chinese, English, German, French, Russian, Japanese, Spanish, Korean and Thai. The menu language of T12D is English by default, You can select any other language you want.

Turn on T12D. Short press Mode button to enter MAIN MENU--Transmitter Settings--SYSTEM SETTING--LANGUAGE, and then select the language you want.

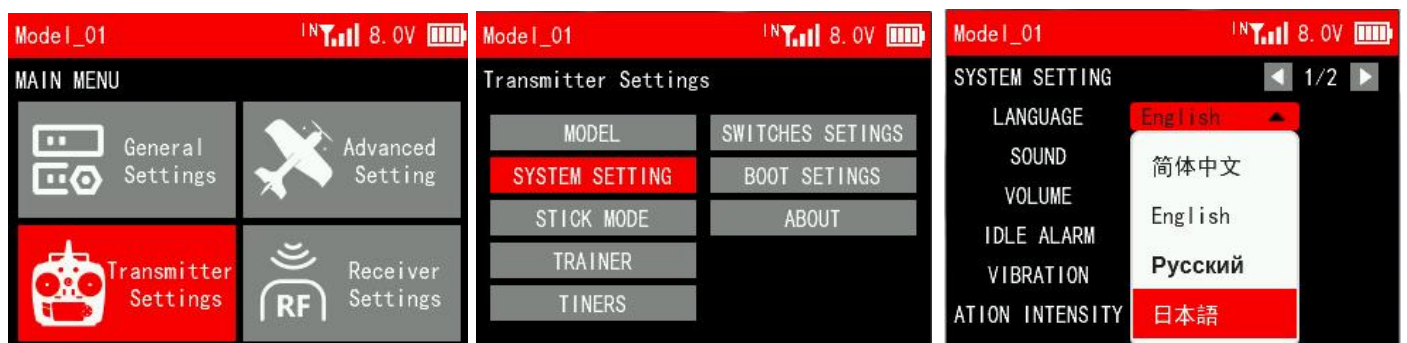

1.2.7 Transmitter Low Voltage Alarm

Transmitter low battery voltage alarm is 6.6V by default. If the battery voltage of transmitter is lower than 6.6V, T12D will make a beeping alarm sound. The battery voltage alarm value can be set based on the actual battery used.

Turn on T12D. Short press Mode button to enter MAIN MENU--Transmitter Settings--SYSTEM SETTING--BATTERY ALARM, and then set the alarm voltage according to your needs. If you use a 2S LiPo battery to power for T12D, it is recommended that the battery alarm voltage be no less than 7.4V; If you use a 3S LiPo battery to power for T12D, it is recommended that the battery alarm voltage be no less than 11.1V.

1.3 T12D Introduction

1.3.1 Features of R16F

T12D transmitter comes with a R16F, 16 channels receiver, with model voltage telemetry supported. 2.4G FHSS spread spectrum algorithm and 67-channel pseudo-random frequency hopping make the R16F get excellent anti-interference performance. R16F supports three signal outputs: PWM, SBUS and CRSF.

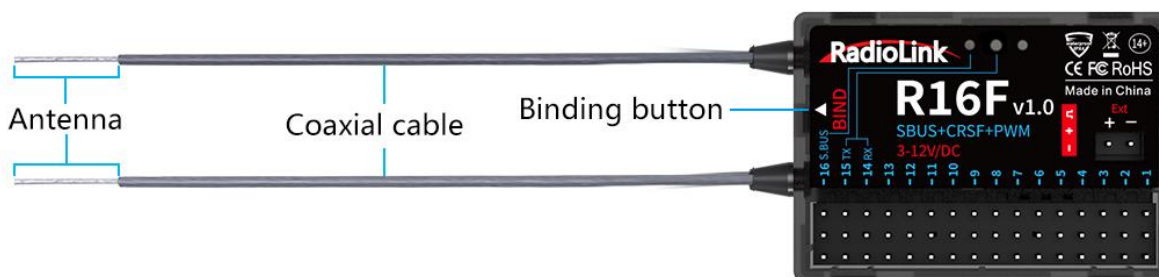
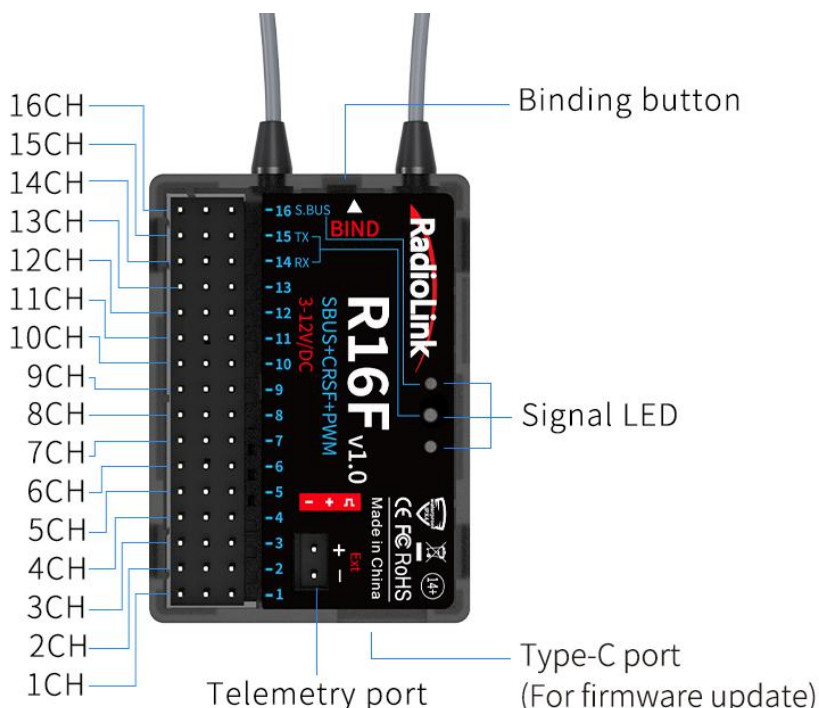

Note: Please do the following safety check before operating your model:

- (1) RSSI test (Received Signal Strength Indicator). For test method, please refer to the manual Chapter 1.3.7 RSSI Testing.
- (2) Antenna inspection: The gray line on R16F is coaxial cable, while the transparent line with a length of about 4-5 centimeters at the top is antenna. If the transparent line is broken or damaged, it will directly affect the control distance. If any abnormality is found, please replace the receiver antenna in time.

1.3.2 Binding

T12D and R16F have finished binding by default. Turn on T12D and R16F. The signal tower will show on the top of the screen as the picture on the right, which means the transmitter and receiver has finished binding.

But if you buy a new R16F receiver for your T12D. You need to bind the receiver to the transmitter. Each receiver has an individual ID code and must bind with transmitter before using.

When the binding is done, the ID code will be stored in the transmitter and there's no need to rebind.

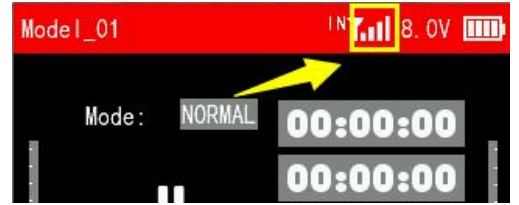

Binding steps:

- (1) Put the transmitter and the receiver close to each other (about 60 centimeters). Note: The close distance of the transmitter and receiver may cause signal block, which leads to unsuccessful binding or signal loss.
- (2) Turn on both the transmitter and the receiver, and then the LED of R16F will start flashing slowly.
- (3) There is a black binding button (ID SET) on the side of receiver. Press the button for more than 1 second and release, the LED will flash quickly, indicate binding process is ongoing.
- (4) When the LED stops flashing and is always on, binding is complete and there will be a signal tower shown on top of the LCD screen of the transmitter. If not succeed, the LED will keep flashing slowly to notify, repeat the above steps.

1.3.3 Receiver Connection

(1) Connect Cable



Picture 1



Picture 2

The connection wire for the receiver is shown in the picture above. The common ones are white/red/black wire (Picture 1) or yellow/red/brown wire (Picture 2). The two types of servo cables both are light-colored wire as the signal wire, and dark-colored wire as the ground wire, and the middle is 5V power supply, and the three wires correspond to " \perp L + - ".

Note: RadioLink receivers are all designed with anti-polarity connect protection. When the receiver is powered by a separate battery, the receiver will not be damaged if the battery polarity is reversed, but if the servo is connected at this time, it will damage the servo.

(2) Telemetry connection

R16F supports telemetry of model battery voltage, receiver voltage and RSSI. Connect one end of the telemetry cable to the R16F telemetry port, and the other end to the ESC to return the power battery

voltage. Please refer to the below picture for connection of the telemetry cable:

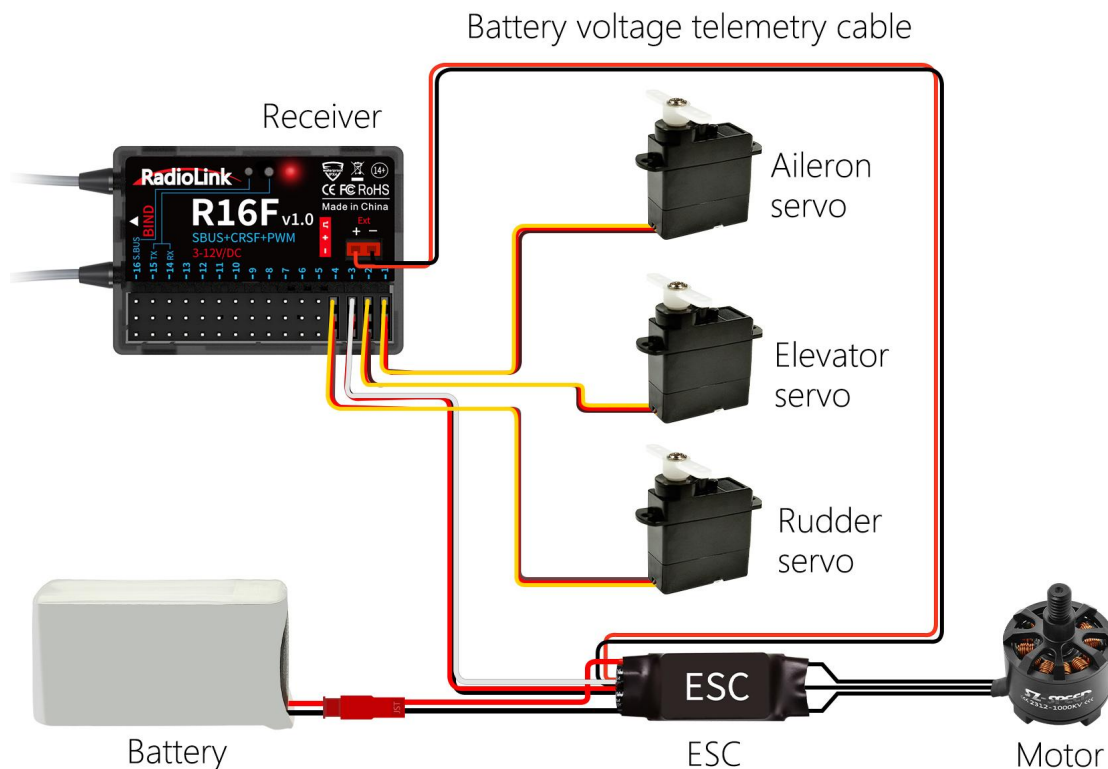

Attention:

- (1) Reverse polarity protection circuit design for all 16 channels of R16F ensures vital components are protected from a reverse polarity connection. But the JST connector which packed with R16F for connect to battery cannot reverse polarity connect, or it will lead to the wrong voltage value telemetry.
- (2) Telemetry port is only used to model voltage telemetry. It can not be used to power the receiver.

1.3.4 Working Modes

R16F supports three signal outputs: PWM, SBUS and CRSF. It has three working modes.

1. PWM working mode

Red LED always on indicates PWM signal output, 16 channels in total.

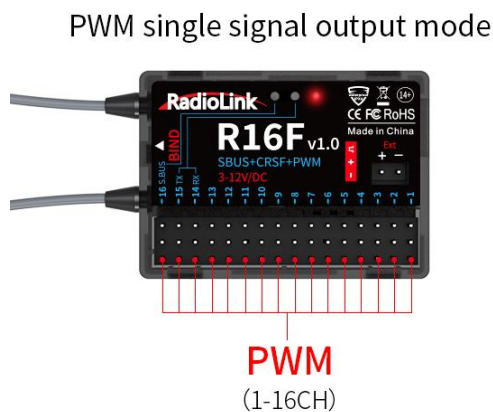

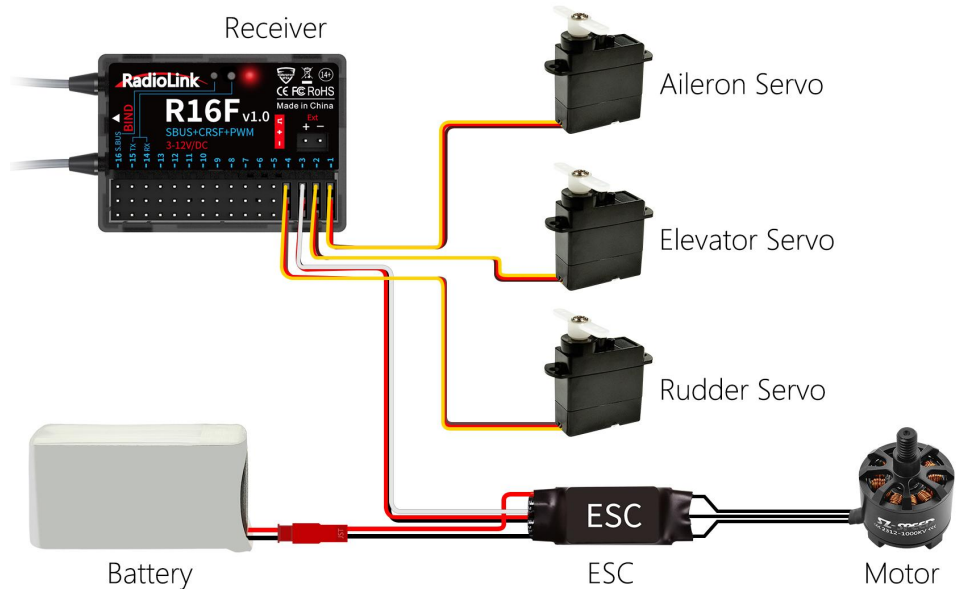

2. PWM+SBUS working mode

Red and blue LED always on indicates PWM+SBUS signals output.

CH1 to CH15 output PWM signal output while CH16 outputs SBUS signal.

PWM+SBUS dual signal output mode

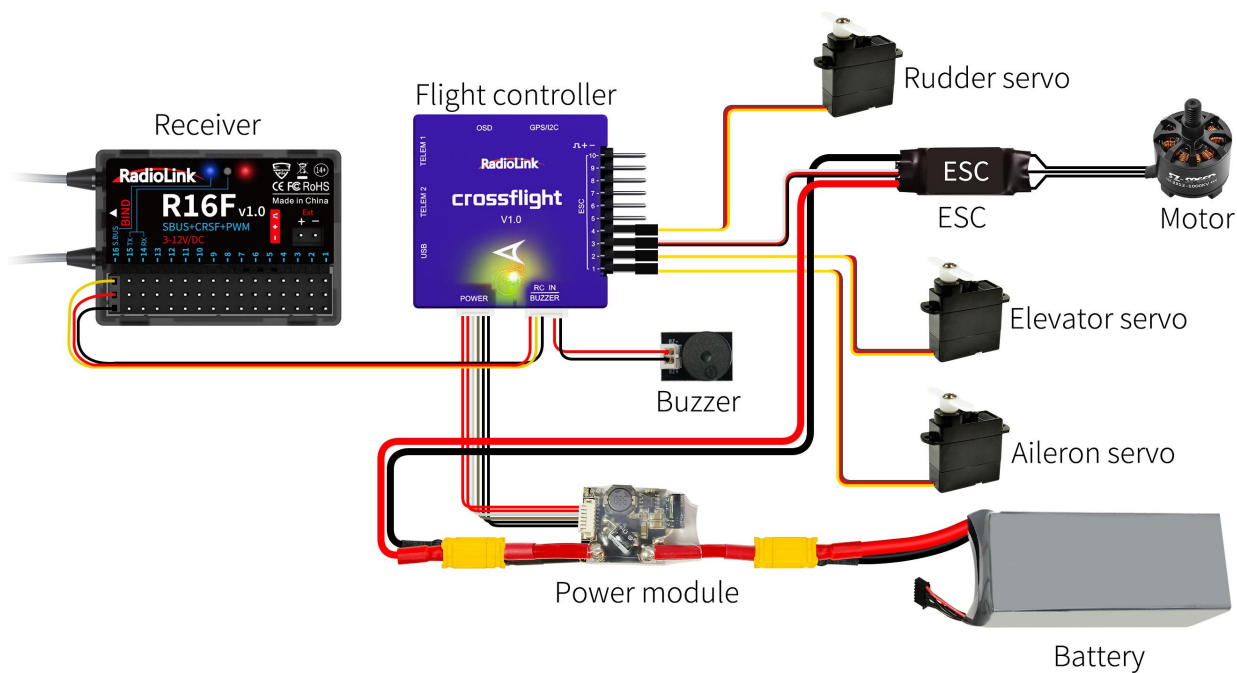
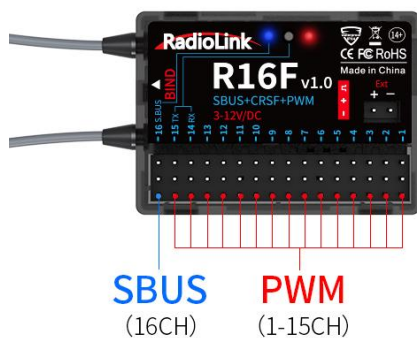

3. PWM+CRSF+SBUS working mode

Red, green, and blue LED always on indicates PWM+CRSF+SBUS signals output.

CH1 to CH13 output the PWM signal, CH14 to CH15 output the CRSF protocol, and CH16 outputs the SBUS signal.

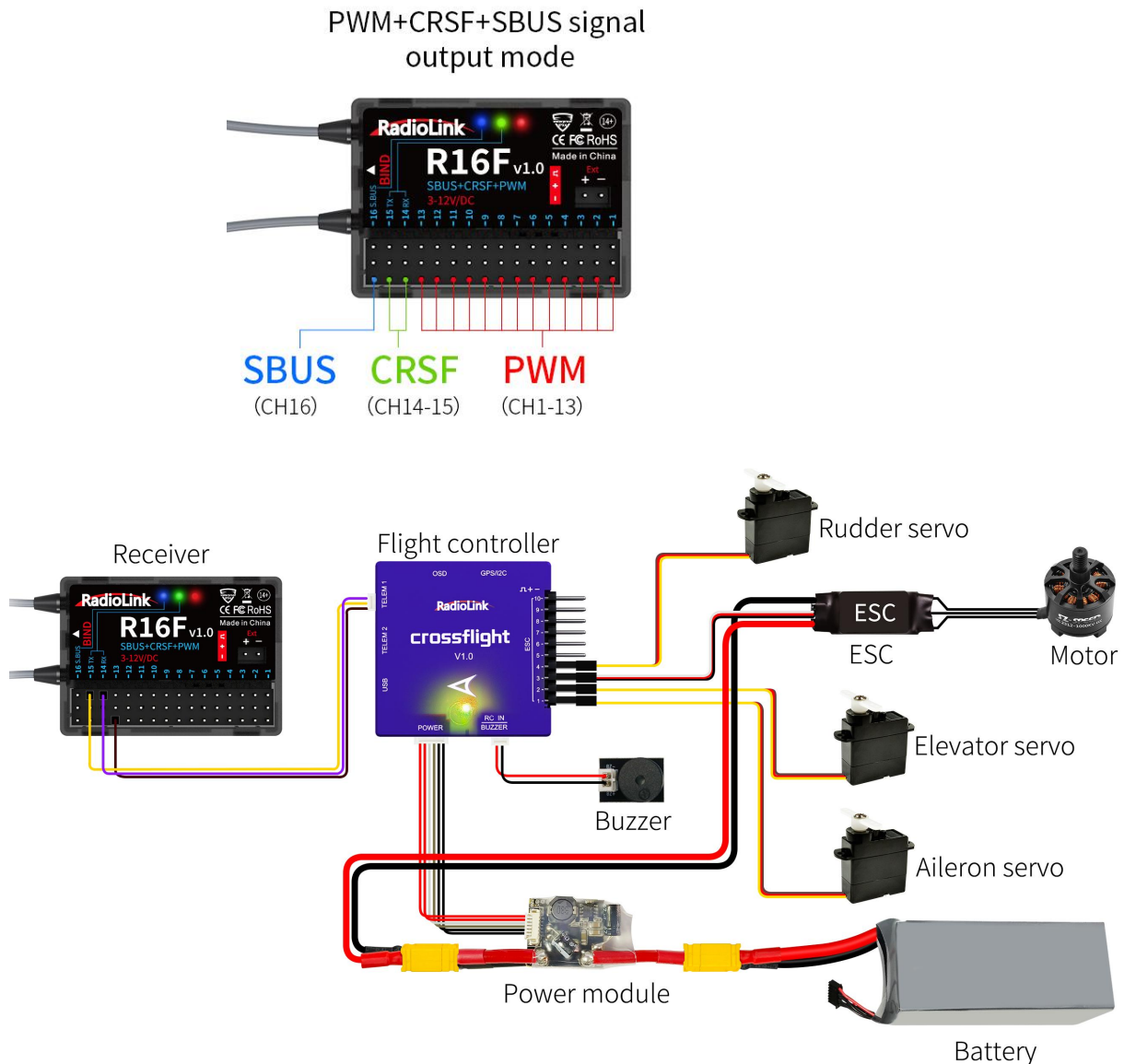

Working mode switch

Short press the binding button once to switch working modes.

1.3.5 Receiver Firmware Update

R16F supports firmware update. The steps for firmware upgrade are as follows:

- (1) Plug a Type-C cable into the Type-C port of R16F.
- (2) Press and hold the binding button of R16F.
- (3) Plug the other end of the Type-C cable into the computer and release the binding button.
- (4) The blue light of the receiver is always on, and a USB flash drive appears on the computer.
- (5) Copy and paste the new firmware of R16F into the USB flash drive to complete the update.

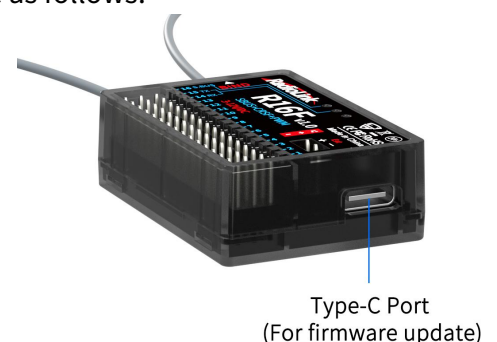

1.3.6 Installment of Receiver Antenna

It is important to install the receiver antenna correctly on the model, because wrong receiver antenna installation will cause poor signal quality.

How receiver antenna installation affects signal quality? Here are the common mistakes when installing the antennas:

- (1) The two antennas of the receiver CANNOT overlap, because they will interfere with each other. Keep the two antennas at a 90-degree angles. (As shown on the right)
- (2) Antennas should NOT be placed near metal objects, because reflection of the conductor panel will drastically worsen the signal.
- (3) Do NOT keep antennas parallel to the ground. It should be placed vertically to the ground.
- (4) Big models may contain metal parts that influence signal emission. In this case. antennas should be positioned at both sides of the model to ensure the best signal status in all circumstances.
- (5) Antennas should be kept away from metal conductor and carbon fiber at least half inch away and no over bending.
- (6) Keep antennas away from motor, ESC or other possible interference sources.
- (7) Sponge or foam material is advised to use to prevent vibration when installing receiver.
- (8) Receiver contains some electronic components of high-precision. Be careful to avoid strong vibration and high temperature.
- (9) Special vibration-proof material for R/C like foam or rubber cloth is used to pack to protect receiver. Keeping the receiver in a well sealed plastic bag can avoid humidity and dust, which would possibly make the receiver out of control.

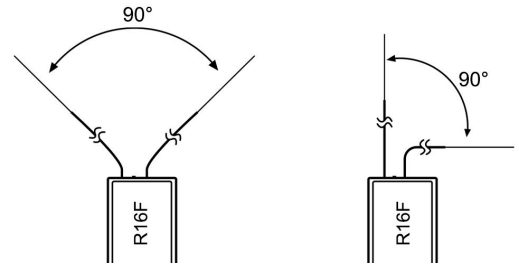

Refer to the following link to view the guide on antenna installation of R16F:

<https://www.radiolink.com/newsinfo/886600.html>

1.3.7 RSSI Testing

If the control distance is short, please refer to this instruction to test the transmitter. This instruction will introduce the test procedure of the transmitter RSSI value and the solution to the abnormal RSSI value.

- (1) Turn on the transmitter and power on the receiver at the same time, and then the transmitter and receiver will be connected (if not connected, you need to bind again). The signal tower appears on the transmitter interface, indicating that the binding is successful. The value of RSSI will appear on the home page, and the RSSI value will keep changing according to the distance between the transmitter and the receiver. (As shown on the right)
- (2) Make the receiver antenna and transmitter antenna parallel. Keep transmitter apart from receiver about 60 centimeters and both antennas straight. It is normal that RSSI value is within the range of 0 to -30dBm. The closer the value is to 0, the stronger the signal is. (As shown below)

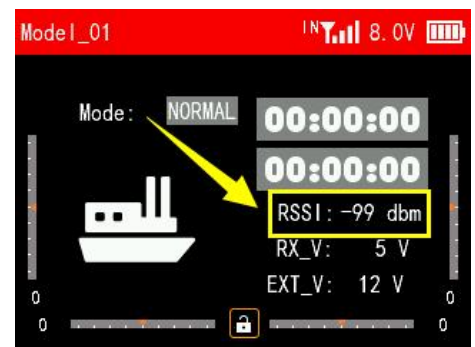

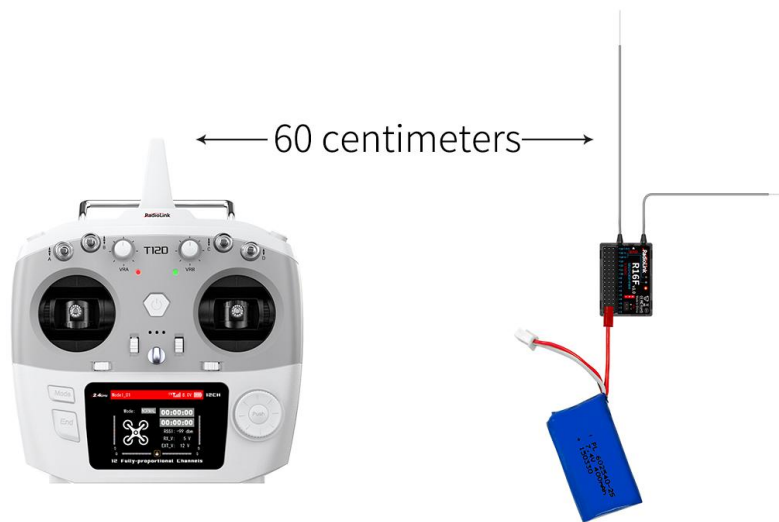

Abnormal signal strength solution:

Check whether the antennas of the receiver and transmitter are damaged. Most signal strength degradation is caused by antenna damage. If it is damaged, the antenna needs to be replaced. If there is no damage, you can test the transmitter and receiver for malfunctions by replacing the receiver. If still cannot solve the problem, email to after_service@radiolink.com.cn to get support.

Chapter 2 General Settings

This chapter introduces all the functions in the [Main Menu]--General Settings.

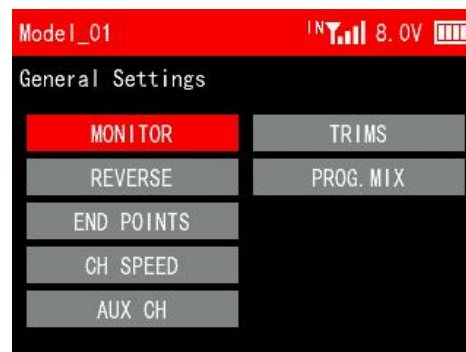
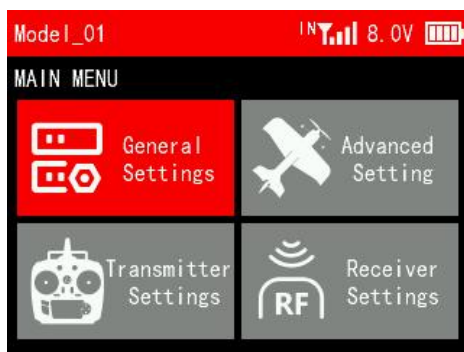

2.1 MONITOR

To display the real-time output status of all channels, you can monitor the current output status of all channels.

Note:

Note: Short press End button on the main interface of T12D to quickly view channel monitor.

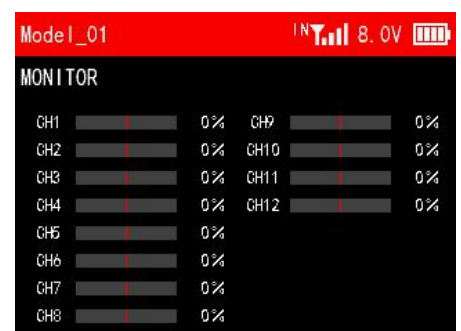

2.2 REVERSE

You can perform the reverse processing of the output data of one channel or more channels. This function is used in the debugging of a model.

Models may follow different standards in the design. In the assembly and debugging of a model, if you find that the operation model is opposite to the required direction, for example, the model goes to the left when you want the right direction, the output signal direction of the transmitter needs to be adjusted at this time. The function is used to adjust the action direction of output signals of each channel.

Move the cursor to the channel that needs to be modified, and short press Push button to switch the direction.

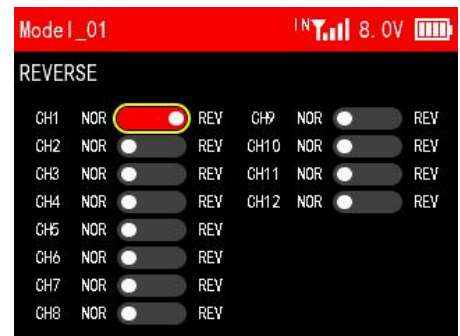

2.3 END POINTS

Adjust the travel amount of the servo output. This function is used in debug. This function can be used to set the travel of the HIGH, LOW and SUBTRIM at both ends of the channel respectively.

When the model is designed, there are changes in the size of the structure and the specification may not be unified. In addition, there may be different sizes of operator's habitual actions. The servo travel function can be used to set the travel amount required for each channel to adjust the corresponding structure for the best match, to obtain the required operation effect. For example, you want to operate that the turning action is not so large, you can adjust the value of the direction channel at both ends to be smaller. In this way, the turning action should be smaller, with less likely to be tailspin.

Move the cursor to the end point value that needs to be set, and rotate Push button to set the appropriate value. The end point can be set from 0 to 120.

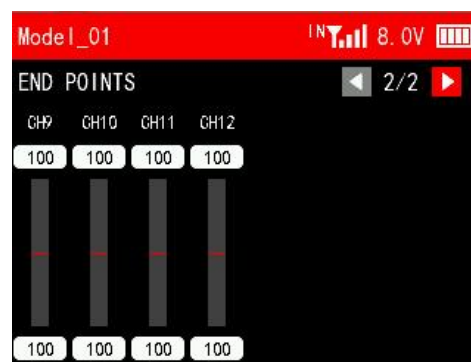
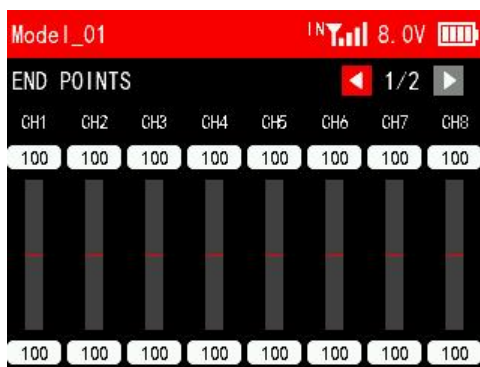

2.4 CH SPEED

CH SPEED (channel speed) function can be used to adjust the output speed of some channels for a specific model. For example, in the landing gear retraction, users may want it to be opened slowly, therefore, you can slow down the output speed of the corresponding channel.

SWITCH: A switch can be set to control the function. You can assign SWA, SWB, SWC and SWD. NULL means no switch assigned.

STATE:

INH: This function is not enabled.

ON/OFF: Turn on/off this function.

Channel speed defaults to 0 seconds, which means no channel delay. Channel speed can be set up to 12 seconds.

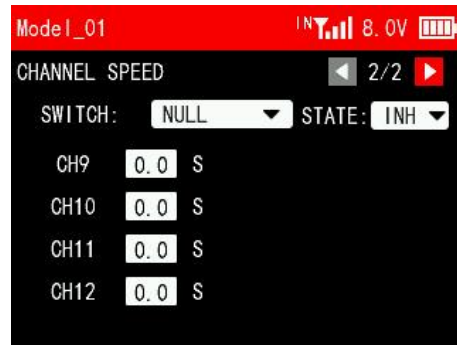

2.5 AUX CH

AUX CH(auxiliary channel) function is used to assign the control switches for CH5 to CH12. You can set SWA, SWB, SWC, SWD, VRA, VRB, VRC and VRD. NULL means no switch assigned.

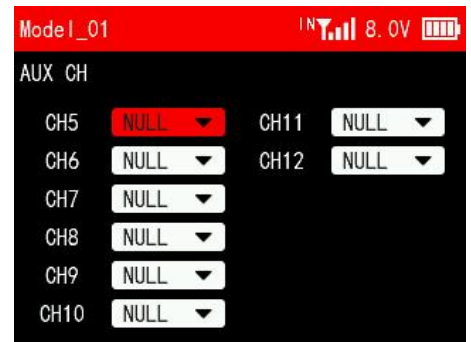

2.6 TRIMS

The function is used to correct mechanical errors, and adjust the neutral position of each channel. The trim of each channel defaults to 0. -100 to 100 can be selected.

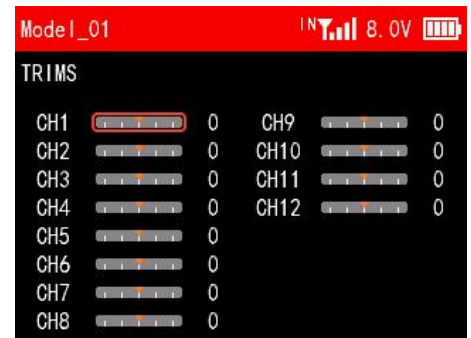

2.7 PROG.MIX

This transmitter provides up to 8 groups of mixing. Mixing can help to control two channels simultaneously with one switch.

PROG.MIX 1/2

SWITCH: The switch to control this group of mixing. You can assign SWA, SWB, SWC and SWD. NULL means the function is not enabled.

STATE:

INH: The mixing is not enabled.

ON/OFF: Turn on/off the mixing.

TYPE: EXP, VTR and CRV.

NOR: Used to adjust the end point ratio on the right side of the slave channel. For example, if the NOR is set to 50, then when operating the master channel, the end point of the slave channel on the right side is only 50% of the master channel. The adjustment range is between -100 and 100. A

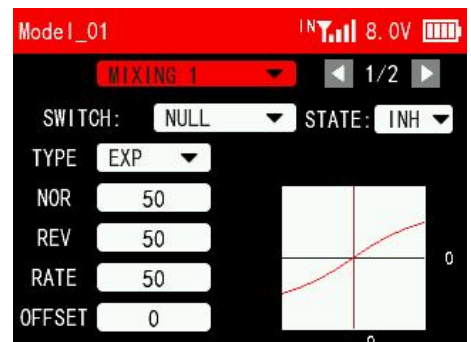

positive number indicates that the slave channel and the master channel move in the same direction, and a negative number indicates that the slave channel and the master channel move in opposite directions.

REV: Used to adjust the end point ratio on the left side of the slave channel. For example, if the NOR is set to 50, then when operating the master channel, the end point of the slave channel on the left side is only 50% of the master channel. The adjustment range is between -100 and 100. A positive number indicates that the slave channel and the master channel move in the same direction, and a negative number indicates that the slave channel and the master channel move in opposite directions.

RATE: Set the EXP, VTR, CRV curve rate of the slave channel. The adjustment range is between -100 and +100.

OFFSET: Set the central point of the slave channel.

PROG.MIX 2/2

MASTER: Master channel that controls the slave channel.

SLAVE: Slave channel that is controlled by the master channel.

LINK: It decides whether the functions on the master channel work on the slave channel. If LINK is turned on, when operating the master channel, the functions set for the master channel will work on both the master channel and the slave channel.

TRIM: It decides whether the trim of the master channel works on the slave channel. If TRIM is turned on, when operating the master channel, the trim of the master channel will work on both the master channel and the slave channel.



Chapter 3 Advanced Settings

This chapter introduces all the functions in the menu Advanced Settings, including TYPE SELECT, FLIGHT MODE, CONDITIONS, RATE/CURVE, THROTTLE CURVE, THROTTLE HOLD, GYROSCOPE, etc. When selecting a model type, the functions applicable to that model type will appear under the advanced settings menu. For example: when the model type is selected as a helicopter, PITCH CURVE and HELICOPTER SETTINGS function will appear.

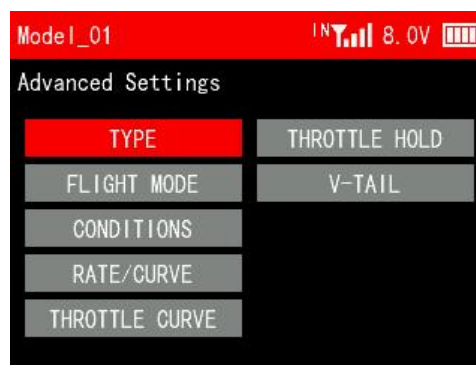
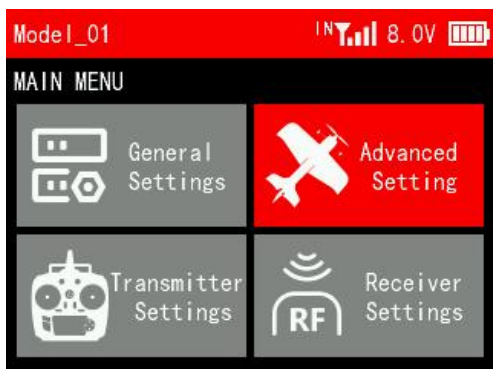

3.1 TYPE SELECT

This function is to select the type of the current model. T12D supports 8 model types including fixed-wing, delta wing, multi-rotor, helicopter, car, boat, tank and robot. When selecting a different model, the functions applicable to that model type will appear under the advanced settings menu.

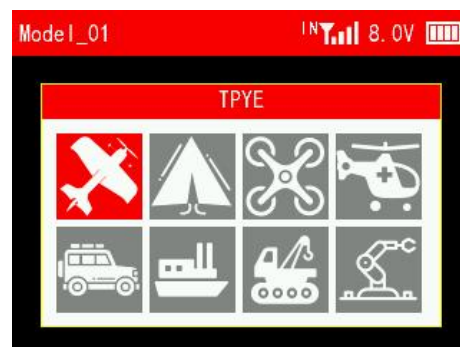

3.2 FLIGHT MODE

Flight mode is used to set and switch among different flight modes, including NORMAL, ATTI, GPS, HOVER, F/S, AUX, ARCO, AUTO, CIRCLE, DRIFT, GUIDED, P.HOLD, RTL, SIMPLE, SPORT, STABL., and LAND, with a total of 17 modes.

This function needs to be used in conjunction with the flight controller. It is mostly used to switch among different flight modes of the flight controller after the model is connected to the flight controller. Match the mode name in the transmitter with the flight mode set in the flight controller, so as to avoid accidental damage and injury caused by errors when changing the flight mode of the flight controller.

Flight Mode 1/2

SW1/SW2: Both SW1 and SW2 are switches for flight mode. SWA, SWB, SWC and SWD can be selected. SWA, SWB, SWC and SWD can be customized as a 2 position switch or a 3 position switch in Switch Settings menu under Transmitter Settings. You can set only 1 witch or set 2 witches at the same time. If only 1 witch is set, the transmitter can only switch between 2 flight modes; If 2 witches are set at the same time, the transmitter can switch up to 9 flight modes.



Move the cursor to the name of the flight model, press the Push button and then turn the Push button to select the flight mode. After setting the mode button, you can toggle the switch. The small red triangle after the flight mode indicates the current flight mode at the current position of the switch.

Flight Mode 2/2

Output channel: The control channel of flight mode, which can be set from channel 5 to channel 12. After the output channel is set, you can toggle the switch to view the channel output value on the current interface.

Ratio: The ratio corresponding to each posture will determine the value output by the posture selection channel when switching to this posture mode. The settable range is -100 to +100.

Move the cursor to the ratio value, short press the Push key and then turn Push to set the ratio. When setting different ratios for each mode, try to avoid setting the ratios of different postures too close, so that the flight control can more accurately identify the posture to be switched. After the ratio setting is

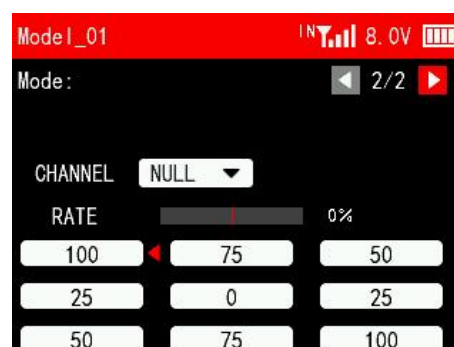

completed, you can toggle the switch. The small red triangle after the ratio corresponds to the ratio value of the current flight mode of the switch.

3.3 CONDITION

CONDITION 1/2

Up to three conditions can be set in a model, and up to three switches can be used to switch conditions.

CONDITION 1/CONDITION 2/CONDITION 3: SWA, SWB, SWC and SWD can be selected to switch conditions. Multiple switches can be used to switch conditions. Condition priority: 3>2>1.

CONDITION 2/2

A list of functions that can be turned on or off using conditional switches, including END POINTS, CHANNEL SPEED, RATE/CURVE, THROTTLE CURVE, GYRO SENSE, V-TAIL, DELTA-WING MIX, PITCH CURVE, TRACK MIX and RF SETTINGS.

If you need to use conditional switches to control the above functions, please turn on the corresponding functions on this interface, otherwise the conditional switches will not take effect.

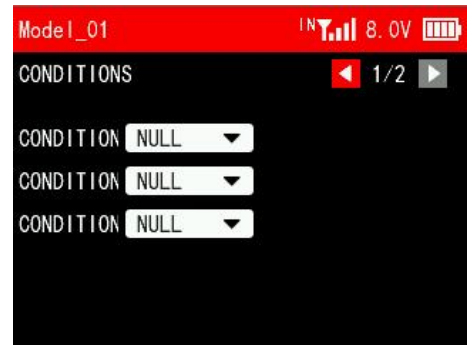

For example: if users needs to use one switch to control 3 different throttle curves, he can follow the following steps to set it:

(1) Set the switches of CONDITION 1/CONDITION 2/CONDITION 3 to SWC_UP/SWC_MID/SWC_DOWN respectively;

(2) Turn on THROTTLE CURVE function on the CONDITION 2/2 interface;

(3) Enter the throttle curve setting interface under the advanced settings menu, push SWC up, which is condition 1, and set the first throttle curve; push SWC to the middle, which is condition 2, and set the second throttle curve; push SWC down, which is condition 3, and set it to the third throttle curve. Flip the SWC to switch between different throttle curves. When the SWC condition switch is placed in different positions, the top taskbar will also display the corresponding condition number (see the picture on the right).

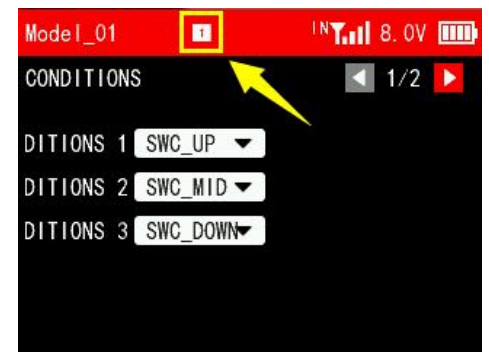

3.4 RATE/CURVE

The function is used to adjust the sensitivity of servo in the left and right side, so that its action changes into linear or non-linear.

CHANNEL: Channel 1, Channel 2 and Channel 4 can be set.

TYPE: EXP, VTR and CRV can be set.

EXP:

RATE: The ratio of the actual output value of the joystick to the original value of the joystick. For example: when the rate is set to 50, it means that when the joystick is at the left and right ends, the actual output of the joystick is 50%. The rate can be set in the range from -100 to +100, and the plus and minus represent the opposite directions of the servo.

EXP: Adjust the sensitivity of the joystick at both ends of the neutral position. When the curve is set to a negative value, the greater the negative value, the lower the sensitivity of the joystick in the neutral position and the higher the sensitivity at both ends; when the curve is set to a positive value, the greater the positive value, the lower the sensitivity of the joystick in the neutral position. The higher the sensitivity in the neutral position, the lower the sensitivity at the ends. The settable range of is from -100 to +100.

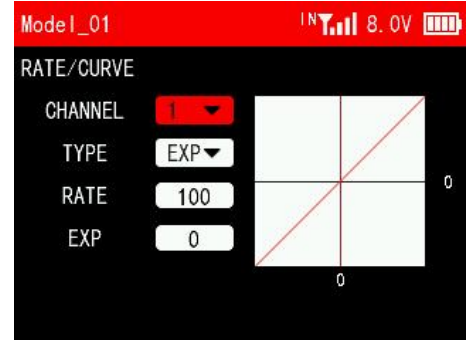

VTR:

RATE: The ratio of the actual output value of the joystick to the original value of the joystick. For example: when the rate is set to 50, it means that when the joystick is at the left and right ends, the actual output of the joystick is 50%. The rate can be set in the range from -100 to +100, and the plus and minus represent the opposite directions of the servo.

VTR: The output range in the first half of the stroke is the current set value, and the output range in the second half of the stroke is 100/-100 minus the current set value. The settable range of the curve is from -100 to +100, and the positive and negative values represent the opposite direction of the servo.

POINT: the critical point of the VTR curve. The settable range is from 0 to 100. For example: when the VTR is set to 30 and the point is set to 70, the value output by the first 70% of the joystick accounts for 30% of the original value of the joystick.

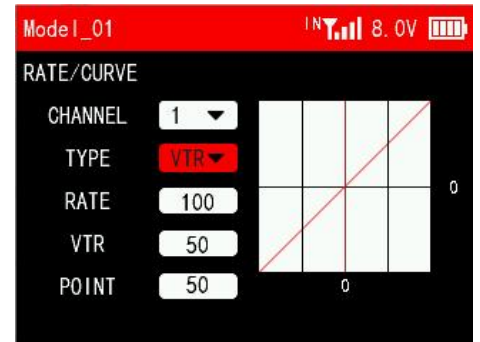

CRV:

Set a 9-point curve type from the lowest point to the highest point of the channel. For example, if point 1 is -100, it means that the travel amount of point 1 is -100, and if point 2 is -75, it means that the travel amount of point 2 is -75. The starting amount of each point is the marked position of the previous point.

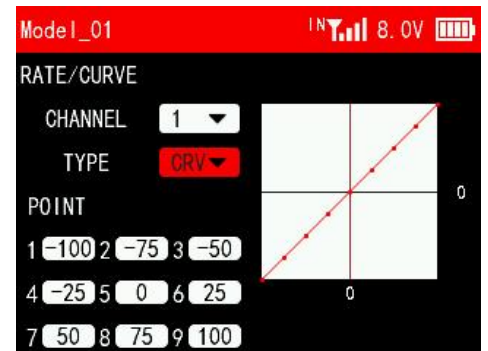

3.5 THROTTLE CURVE

The throttle curve can make the throttle operation more sensitive or smooth during acceleration and braking, making the throttle action change linearly or non-linearly.

TYPE: EXP and CRV can be set.

EXP:

EXP: Adjust the sensitivity of the throttle from the center point to the high point. When the curve is set to a negative value, the greater the negative value, the lower the sensitivity of the joystick at 50% throttle, and the higher the sensitivity at low and high throttle positions; When the curve is set to a positive value, the positive value the larger it is, the more sensitive the joystick is at 50% throttle and the less sensitive it is at low and high throttle. The settable range of the curve is from -100 to +100.

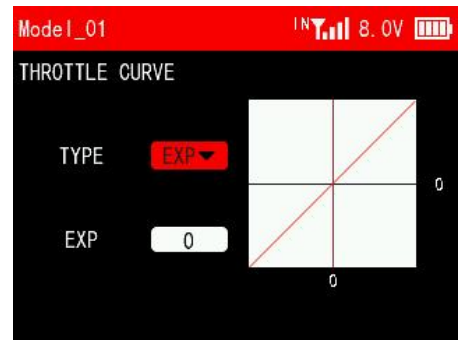

CRV:

Set a 9-point curve type from the lowest point to the highest point of the throttle. For example, if point 1 is -100, it means that the travel amount of point 1 is -100, and if point 2 is -75, it means that the travel amount of point 2 is -75. The starting amount of each point is the marked position of the previous point.

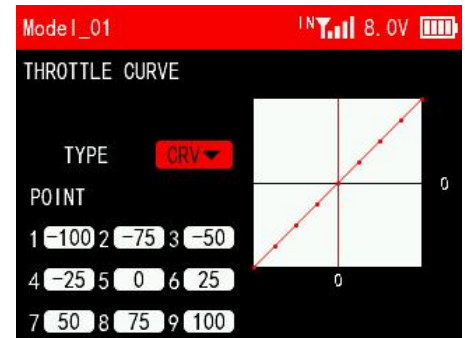

3.6 THROTTLE HOLD

Throttle hold, or the cruise control function can set the throttle output to a fixed value. When the throttle hold is turned on, the throttle output will jump to the locked position regardless of the current throttle position. For example, when using a crawler, you can turn on the cruise control with a switch, and the crawler can maintain a constant speed without touching the trigger.

SWITCH: SWA, SWB, SWC and SWD can be set.

THRO: Fixed output value of the throttle. The setting range is 0 to 100, 0 means the fixed throttle output value is -100%, 50 means the fixed throttle output value is 0%, and 100 means the fixed throttle output value is 100%. When setting parameters, you can check the set throttle output value through the bar of channel 3 below.

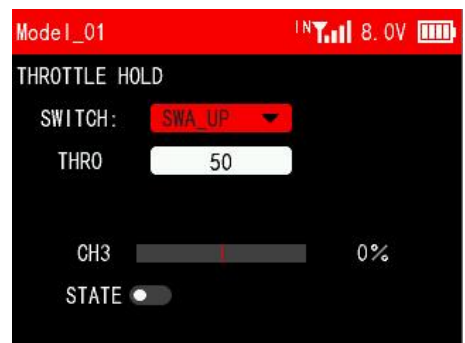

STATE: The current status of the throttle lock. A white dot on a black background indicates off, and a white dot on a red background indicates on.

3.7 V_TAIL (Fixed-wing)

This function is set for some specific aircraft models, for example, fixed-wing aircraft with V-tail. You can perform mixing control for both channels in the same direction and reverse direction.

STATE: Turn on/off this function.

CH2/CH4: Adjust the values of CH2 and CH4 to determine the range and direction of the movement of the elevator or rudder servo in response to the elevator or rudder joystick.

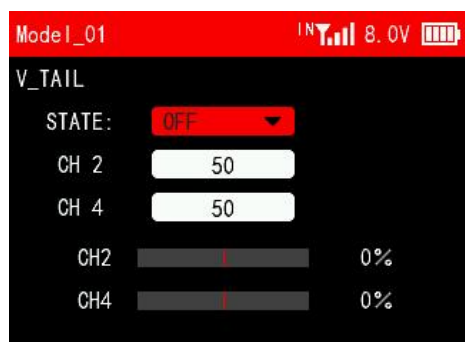

3.8 DELTA-WING MIX (Delta-wing)

Delta-wing mix is also called elevon mix. It is commonly used in delta wing aircraft. Two servos independently control the two surfaces on the left and right sides of the aircraft, and they can work as both the ailerons and elevators.

STATE: Turn on/off this function.

CH1/CH2: Adjust the values of CH1 and CH2 to determine the range and direction of the movement of the aileron or elevator servo in response to the aileron or elevator joystick.



3.9 GYROSCOPE

The function is used to adjust the gyroscope sensitivity. When adjusting the gyro sensitivity, please make sure the receiver has a built-in gyroscope and the gyroscope function of the receiver is turned on.

GYRO SENSE: The sensitivity can be set from 1% to 100%. 100% means the strongest sensitivity. When set to off, the gyroscope is turned off.



3.10 PITCH CURVE (Helicopter)

This function is set to adjust the helicopter's pitch motion curve to match the throttle output to achieve the best flight status of the helicopter.

OUTPUT CHANNEL: The output channel of the pitch curve. You can select channel 5 to channel 12. When the output channel is set to NULL, the function is not enabled.

POINT: The setting point of the pitch curve. A total of 9 points can be set, and the parameters can be set from -100 to +100.

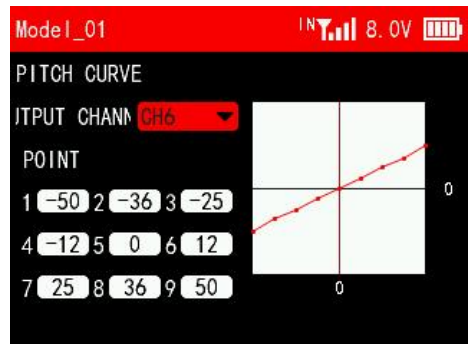

3.11 HELICOPTER SETTINGS (Helicopter)

The function is to set the mix control of the helicopter's aileron, elevator, and pitch servos in the current mode to achieve the best flight effect.

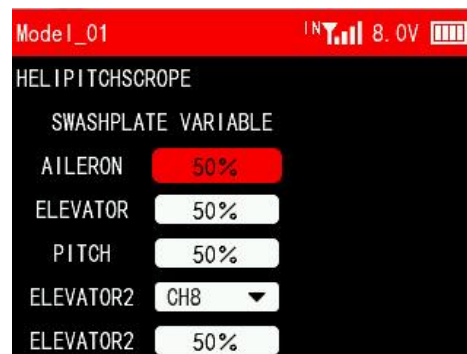
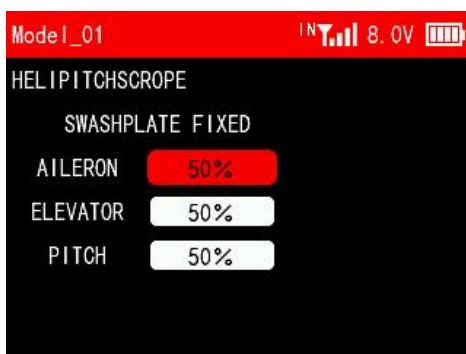

3.12 TRACK MIX

This function is to set for some specific models, such as tank, excavator models. Two tracks can be driven in the same direction or in the opposite direction.

STATE: Turn on/off this function. You can select channel 1 to channel 12, which are determined by the receiver channels two motors connected to respectively. The default channels are CH5 and CH6.

FORWARD RATIO: The ratio of the throttle output value and the original throttle value of the two tracks moving forward.

BACKWARD RATIO: The ratio of the channel output value and the original channel output value of the two tracks moving backward.

LEFT RATIO: The ratio of the channel output value and the original channel output value of the two tracks turning left.

RIGHT RATIO: The ratio of the channel output value and the original channel output value of the two tracks turning right.



Chapter 4 Transmitter Settings

This chapter introduces all the functions in the menu Advanced Settings, including MODEL, SYSTEM SETTINGS, STICK MODE, TRAINER, TIMERS, SWITCHES SETTINGS, BOOT SETTING, and ABOUT.

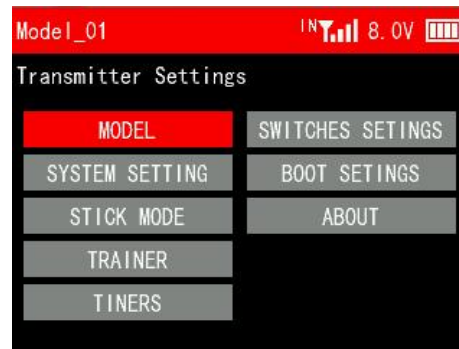
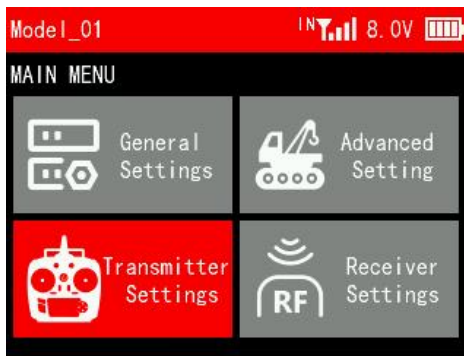

4.1 MODEL

The MODEL menu is used for model management, including model select, model type, mode copy/paste, rename and model reset.



4.1.1 Model Select

T12D can store up to 100 sets of model data, and you can select the model you want at any time.

4.1.2 Model Type

A total of eight different types of models are provided, including fixed-wing, delta wing, multi-rotor, helicopter, car, boat, tank and robot. Users can also select the model type under the advanced settings menu.

4.1.3 Model Copy/Paste

When a new model is the same or similar to a previously used model, you can use this function to copy it in order to quickly complete the settings.

For example, if you need to copy the data of model 1 to model 2, you can select model 1 and click copy, then select model 2 and click paste. Please note: When copying a new model, the name of the original model will also be copied. You need to distinguish and rename the new model to avoid confusion.

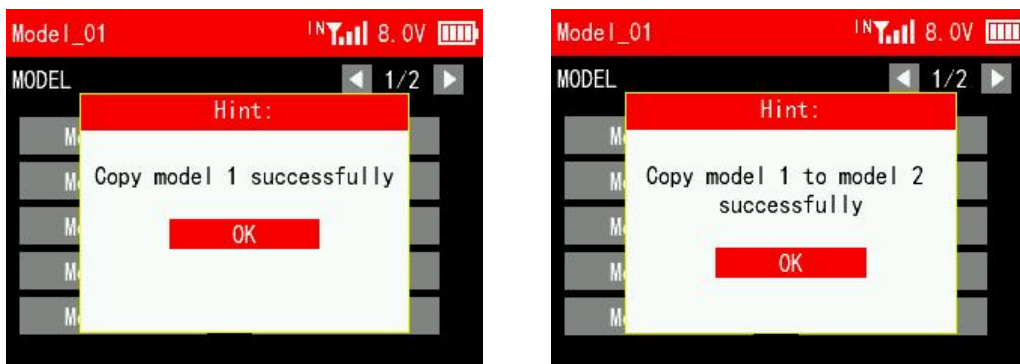

4.1.4 Model Rename

You can write and change the model name for the selected model.

4.1.5 Model Reset

Model reset is to clear all the settings of the current model and restores the current model to default values.

4.2 SYSTEM SETTING

SYSTEM SETTING menu is used to set language, sound, volume, idle alarm, vibration, vibration intensity, battery type, battery alarm, calibration voltage, brightness, brightness time and auto shutdown.

SYSTEM SETTING 1/2

LANGUAGE

The menu interface is available in multiple languages, including

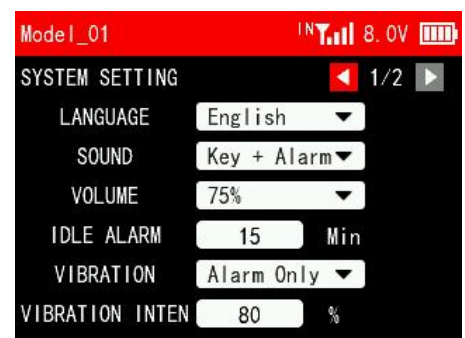

Chinese, English, German, French, Russian, Japanese, Spanish, Korean and Thai. The menu language of T12D is English by default, You can select any other language you want.

SOUND

Sound is to set the sound for system and alarm. You can select alarm only, key only, key plus alarm.

VOLUME

Volume is to set the volume of the sound. You can set it to mute, 25%, 50%, 75% and 100%. 100% is the maximum volume.

IDLE ALARM

Idle alarm is to set the alarm time when there is no operation on the transmitter. When the transmitter is on standby for a long time without operation, an idle alarm can be set to remind the user to avoid over-discharging of the battery caused by long-term standby. The idle time can be set from 0 to 360 minutes.

VIBRATION

Vibration is to set the vibration of the system and alarm. You can select alarm only, key only, key plus alarm. NULL means there is no vibration.

VIBRATION INTENSITY

Vibration intensity is to set the vibration grade. You can set it from 0 to 100%.

SYSTEM SETTING 2/2

BATTERY TYPE

Set the battery type to accurately view the capacity of the battery icon in the upper right corner. If the wrong battery type is selected, the battery icon capacity in the upper right corner will display an error.

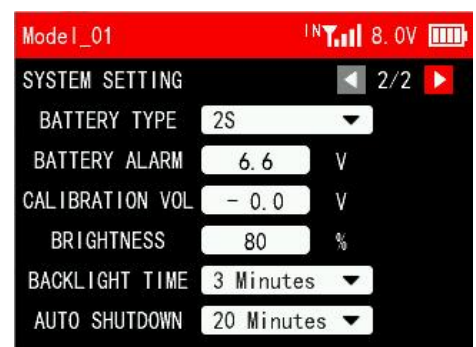

BATTERY ALARM

Battery alarm is to set alarm voltage for the battery of the transmitter. When the battery voltage is lower than the alarm voltage, an alarm will sound. Battery alarm defaults to 6.6V.

CALIBRATION VOLTAGE

When there is a difference between the battery voltage displayed and the actual battery voltage, you can set calibration voltage to make the voltage display consistent. The adjustment range is between -5V and +5V

BRIGHTNESS

Brightness is to set the brightness of the screen.

BRIGHTNESS TIME

Backlight time is to set the time of the backlight, namely how long the screen stays on when there is no operation. NULL means the screen won't go off when there is no operation for a long time. You can set at most 1 hour.

AUTO SHUTDOWN

AUTO shutdown is to set the time of auto shutdown, namely how long the transmitter will turn off automatically when there is no operation. NULL means transmitter won't turn off automatically when there is no operation for a long time. You can set at most 1 hour.

4.3 STICK MODE

T12D provides four stick mode, you can set it according to your habit. Mode2 is the default mode. Changing between modes 2/4 and modes 1/3 will need to modify the throttle stick.

When there is any problem with the servo display of the transmitter or the servo value does not return to 0, you may need to calibrate the joystick of the transmitter. Here are the joystick calibration methods:

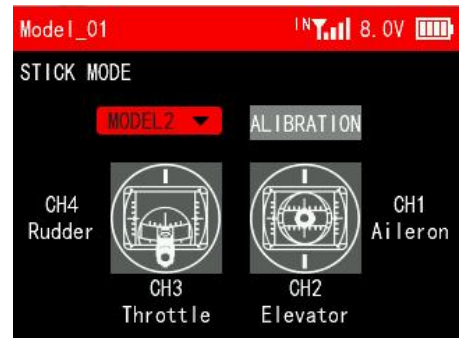

1. Move the cursor to CALIBRATION and press Push button to confirm it.

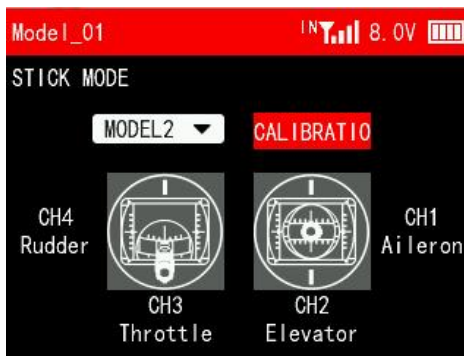

2. Move the two sticks to the middle position, and press Push button to confirm it.

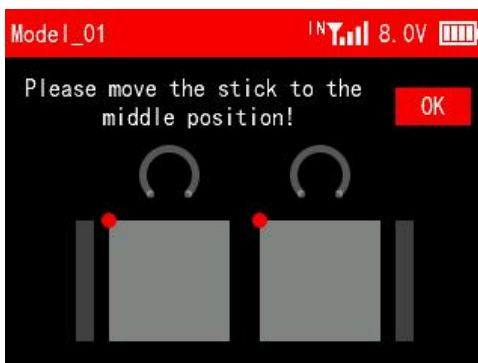

3. There is a prompt to move the joystick/knob to maximum/minimum stroke, and press Push button to confirm it.

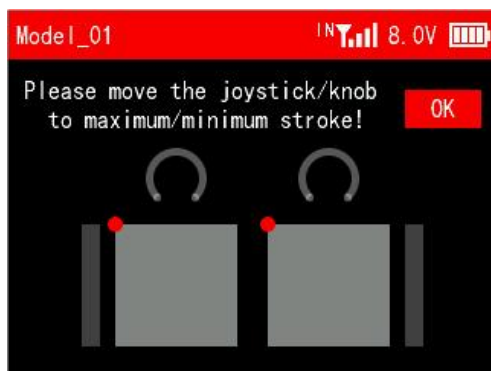

Push the two joysticks to the lower left corner, lower right corner, upper right corner, upper left corner respectively. Refer to the picture below:



Turn the knob, VRA and VRB, clockwise to the maximum, and then counterclockwise to the minimum. Refer to the picture below:



4. Then press Push button to confirm it. The calibration is done.

4.4 TRAINER

SWITCH: A switch can be used to turn on/off the PPM signal input and output. Optional switches include SWA, SWB, SWC and SWD. NULL means no switch assigned.

STATE:

INH: This function is not enabled.

ON/OFF: Turn on/off this function.

MODE:

INPUT: Select input mode when the simulator port of the T12D is connected to FPV goggles with head track function.

OUTPUT: Select output mode when the simulator port of the T12D is connected to the simulator or trainer cable. When using the trainer function, T12D can be used as both a master and a student transmitter.

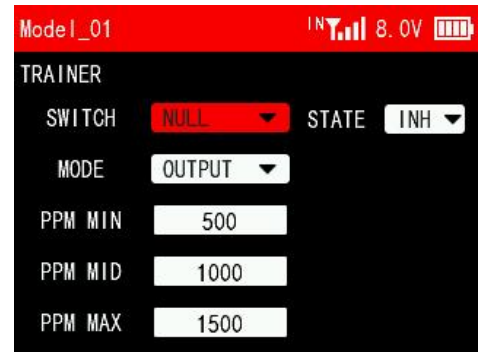

Note:

1. The master and the student transmitters need to be connected with a trainer cable. When using the trainer function, please first check whether the trainer cable is connected properly;
2. The trainer function will only take effect when the control switches of the master and the student transmitters are both turned on. Otherwise it will be invalid.

PPM MIN/PPM MID/PPM MAX: Used to adjust the pulse width of PPM input and output. Due to the compatibility of different head track or trainer devices, when the PPM neutral point, maximum value, and minimum value cannot correspond, you can modify the PPM MIN/PPM MID/PPM MAX here.

4.5 TIMER

Timer display and control settings. T12D provides 2 timers, which can be set independently. The setting method is the same.

TIMER 1/2

TYPE: There are two modes available, including UP and DOWN. UP: The timing starts from 0. DOWN: The timer starts counting down from the set time.

ALARM: Alarm time. When the timing time reaches the time set here, the transmitter will start to sound an alarm. It defaults to 5 minutes.

ON/OFF: A switch can be used to start and stop timing. Optional switches include SWA, SWB, SWC and SWD.

RESET: A switch can be used for timing reset. If the timing has already started, push the reset switch once and the timing will start again; If the timing stops, push the reset switch once and the timing will be reset.



Note: After the timer ends, you need to push the reset switch once to reset the timer before starting the next timer.

ALARM:

INH: When the timer ends, no alarm beeping.

ON: When the timer ends, the transmitter will sound a beeping alarm.

VIBRATION:

INH: When the timer ends, no vibration.

ON: When the timer ends, the transmitter will vibrate to prompt.

TIMER 2/2

Please refer to Timer 1.

4.6 SWITCH SETTING

SWITCH SETTING 1/2

This function can set 2 position switches as 3 position switches or the 3 position switches as 2 position switches. If the physical switch is replaced, this function can be used to set the corresponding switch type. You can set the switch types of SWA, SWB, SWC and SWD.

For example, when the 2 position switch SWD is set to 3 position switch, keep holding SWD in the middle position, it is the middle gear, SWD_MID; when the 3 position switch SWC is set to 2 position switch, the middle gear SWC_MID does not take effect.

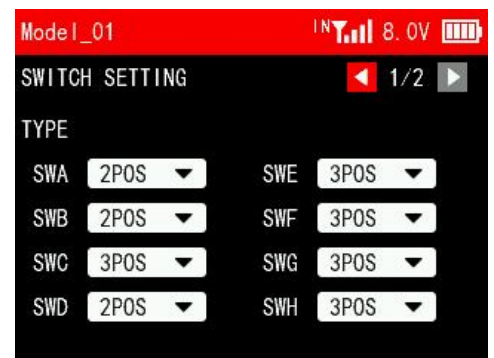

SWITCH SETTING 2/2

SELF CHECK: Used to turn on/off the switch self check. A white dot on a black background indicates off, and a white dot on a red background indicates on.

SWA, SWB, SWC and SWD can be set to UP/MIDDLE/DOWN.

If you need to put SWA, SWB, SWC and SWD in a specific position (such as UP/MIDDLE/DOWN) when the transmitter is turned on, you can turn on the switch self check, and the switch self check function is turned off by default.

For example: Turn on the switch self check function and set SWA to DOWN here. When the transmitter is turned on next time, if SWA is not in the lowest position, the transmitter interface will prompt "SWA is not at the set position. Press ↓". Please push SWA to the lowest position, and the warning will be released.



4.7 BOOT SETTINGS

This setting is used to turns on/off the startup animation.

4.8 ABOUT

Users can view the Radiolink website, hardware version, software version and device name here.

Reset System Settings

All parameters in the "System Settings" menu except "Language" can be reset.

Click "Reset System Settings", the screen will prompt "Do you want to reset system settings?". Select "Yes" and the system settings are reset.



Factory Reset

All parameters of the transmitter can be reset, including system setting parameters and all model data.

Note: If you just need to clear the current model parameters, please reset the current model in the MODEL menu in Transmitter Settings. Factory reset here will clear all model data. Once the model data is cleared, it cannot be restored, so please use this function with caution!

Click "Factory Reset" and a prompt will appear on the screen asking if you need to restore factory settings. Select "Yes" and wait for about a minute to reset all the settings.



Chapter 5 Receiver Settings

This chapter introduces all functions in the menu Receiver Settings, including RF SETTINGS, SUBSIDIARY ID , SENSOR, FAILSAFE and EXT RF SETTINGS.

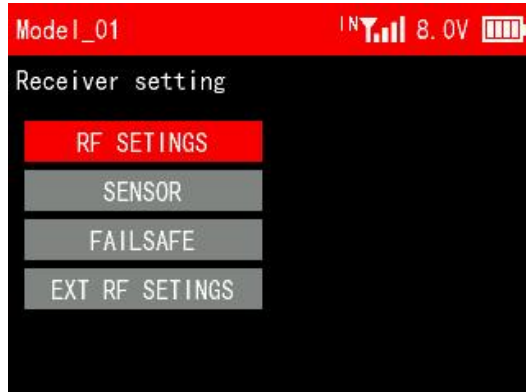

5.1 RF SETTINGS

Module selection: Internal and External can be selected.

When the transmitter is connected to an external module, select external in "Module Selection", and EX will be displayed next to the signal tower on the taskbar.

When the transmitter is not connected to any external module, select internal in "Module Selection", and IN will be displayed next to the signal tower on the taskbar.

Note: T12D only supports CRSF protocol modules, such as TBS, ELRS module.

PROTOCOL: The protocol of the receiver. FHSS V1 or FHSS V2 can be selected. FHSS V1 receivers have a PWM output resolution of 2048, and FHSS V2 receivers have a PWM output resolution of 4096. FHSS V2 can achieve a more precise operation.

SERVO SPEED: Servo response speed. 14ms, 4ms, 3ms can be selected. 14ms is the response speed of the analog servo. 4ms and 3ms are the response speeds of the digital servo. If you are using a digital servo, you can select a servo speed of 4ms or 3ms. Please confirm whether the receiver you are using supports digital servo. Currently, RadioLink receivers that support digital servos include R8FGH, R8FG V2.1 version, R4FGM V2.1 version, and R8FG and R4FGM receivers with a factory date of 2023/4/26 or later. Other versions of RadioLink receivers do not support digital servo. Even if 4ms or 3ms is selected when using them, the default servo speed is 14ms. RadioLink will continue to add other models of receivers that support digital servos in the future. Please pay attention to RadioLink official website.

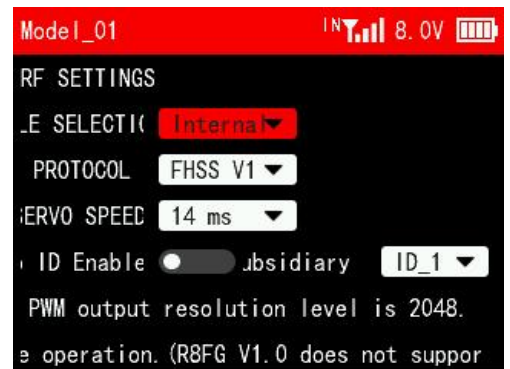

5.2 SUBSIDIARY ID

T12D can bind with multiple receivers. When T12D and multiple receivers have been bound successfully, and T12D and all successfully paired devices are turned on at the same time. There are two ways to use them:

1. When Subsidiary ID function is turned off, T12D can control multiple devices at the same time.

2. When Subsidiary ID function is turned on, T12D can control the specified device according to the selected Subsidiary ID. T12D has 16 groups of Subsidiary ID functions, and each ID corresponds to a receiver. Set the Subsidiary ID first. When all the devices are turned on, you can control one of the devices through the Subsidiary ID function. At this time, the other devices are on standby.

For example: Bind T12D with a truck and a car and turn all them on. First, use T12D to control the car to run to the bucket of the truck, and then switch the receiver ID on the truck to drag the car back to the destination.

Subsidiary ID function setting steps:

1. Turn on Subsidiary ID function. Then set the ID number according to your models and then finish the binding and parameters set for each receiver.

2. Once the Subsidiary ID is turned on, the corresponding ID number will be displayed on the main interface of T12D.

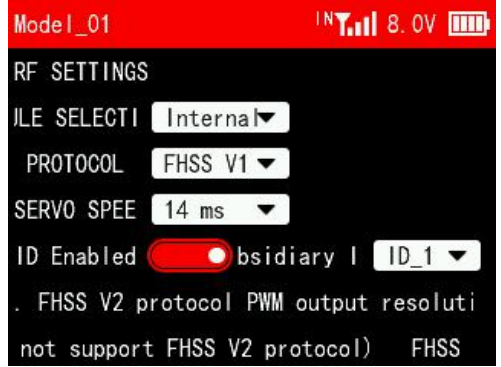

5.3 SENSOR

The function is used to set alarms for RSSI, receiver voltage and external battery voltage.

Alarm interval: When the RSSI value, receiver voltage and external battery voltage reach the alarm values respectively, the transmitter will issue an alarm prompt. It defaults to alarm once every 10 seconds, the alarm interval time can be customized.

RSSI ALARM: The alarm can be turned on/off. A white dot on a black background indicates off, and a white dot on a red background indicates on.

RSSI ALARM VALUE: When the RSSI value of the receiver reaches the RSSI alarm value, the transmitter will issue an alarm. The maximum value can be set to -100dbm, and the default value is -80dbm. The specific alarm value can be set based on the control range you want.

RX VOLTAGE ALARM: The alarm can be turned on/off. A white dot on a black background indicates off, and a white dot on a red background indicates on.

RX VOLTAGE VALUE: When the receiver voltage reaches the receiver voltage alarm value, the transmitter will issue an alarm. The minimum alarm value can be set to 3V. The maximum can be set to 12V. It defaults to 4.2V.

EXT VOLTAGE ALARM: The alarm can be turned on/off. A white dot on a black background indicates off, and a white dot on a red background indicates on.

EXT BATTERY VOLTAGE ALARM VALUE: When the external battery voltage reaches the external battery voltage alarm value, the transmitter will issue an alarm. The minimum can be set to 3V. The maximum can be set to 60V. It defaults to 6.6V.

Note: If you need to use the alarm function, please make sure that the alarm sound or vibration is turned on in the system settings menu.

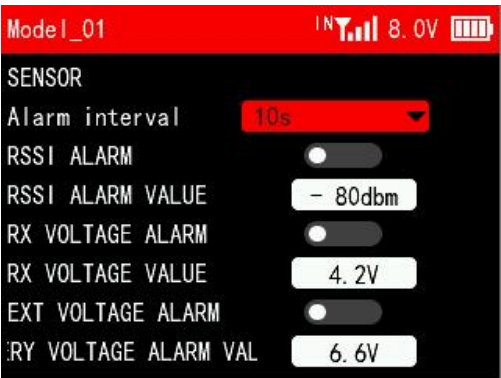

5.4 FAILSAFE

Fail safe is an important safety setting. When the signal is lost, it can be used to protect the model from loss or reduce the degree of loss. It can also play a certain protective role in personnel safety. This function sets the output value performed by each channel when the signal is lost. All channels default to 0% and can be customized according to the needs of the device.

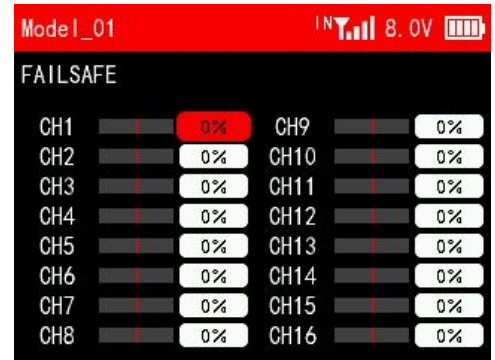

5.5 EXT RF SETTINGS

EXT RF SETTING 1/2

Module selection: Internal and External can be selected.

When the transmitter is not connected to any external module, select internal in "Module Selection", and IN will be displayed next to the signal tower on the taskbar.

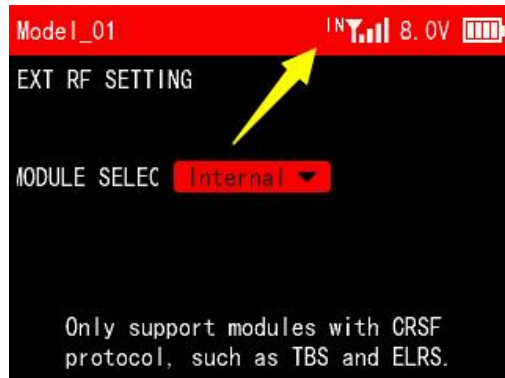

When the transmitter is connected to an external module, select external in "Module Selection". After selecting external, EX will be displayed next to the signal tower on the taskbar. At this time, more setting parameters will appear on the current interface, such as PROTOCOL, BAUD RATE, Pkt Rate, TLM Ratio, TX Power, Bind, WIFI Mode and firmware version.

Note: T12D only supports CRSF protocol modules, such as TBS, ELRS module.

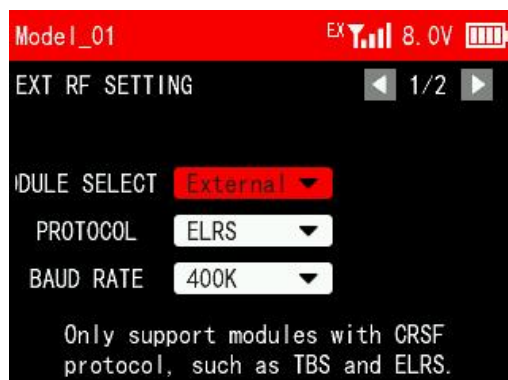

PROTOCOL: ELRS and CRSF V2 are optional. Different protocols are selected when different modules are used.

Baud rate: optional 115200, 400K, 921K and 1.87M. When the data rate is 50Hz, select 115200; when the data rate is 50~250Hz, you can select 400K; when the data rate is 500Hz, select 921K; when the data rate is 1000Hz, select 1.87M.

EXT RF SETTING 2/2

Pkt Rate: RF transmitter packet rate.

TLM Ratio: Receiver telemetry ratio.

TX Power: RF TX module output power.

Bind: Set the RF TX module into binding status. BEGIN or CANCEL is optional. BEGIN means to set the RF TX module into binding status.

WIFI mode: DISABLE or ENABLE is optional. DIABLE means the function is not enabled, ENABLE means the WIFI function is opened for firmware updates.

Firmware: The current firmware version of the module.

Note: When T12D is connected to the module and the parameters are read successfully, you can set the parameters of module on this interface. When T12D is not connected to the module or the parameter reading fails, all options on this interface are displayed as --. Parameters cannot be set.



Chapter 6 Firmware Update

T12D will keep updating the firmware to add new functions or optimize the current functions. Please pay attention to our website www.radiolink.com to get the latest firmware.

Firmware update steps:

1) Download firmware

>Download the latest firmware from https://www.radiolink.com/t12d_firmwares The firmware of T12D is a mac file.



2) Prepare the transmitter

>Connect battery to T12D. Power off the transmitter.

>Push these two TRIM buttons to the middle, and long press the power button at the same time until you hear a D sound.



3) Enter USB mode

>The following BOOT MODE interface will appear on the screen of the transmitter. Select "USB MODE" and press the Push button to confirm.

>The following USB MODE interface will appear on the screen, indicating that it has entered USB mode, and the computer will also remind you that a USB flash drive is inserted.

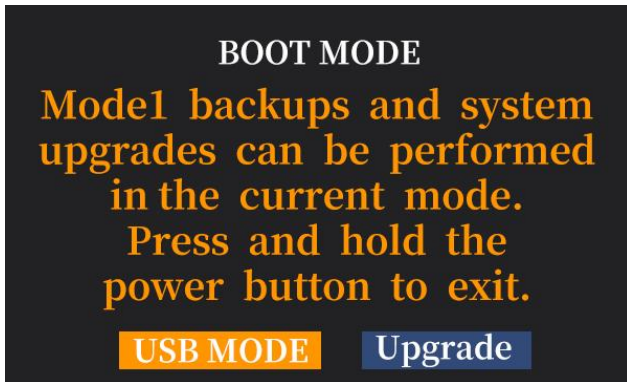

4) Copy the firmware

>The computer will display the removable disk of T12D. Open the disk and there will be a firmware folder.

>Copy the firmware that you have downloaded into this firmware folder.



5) Enter Upgrade mode

>After the firmware copy is complete, short press the End button to exit USB mode.

>The following BOOT MODE interface will appear on the screen. Select "Upgrade" and press the Push button to confirm.

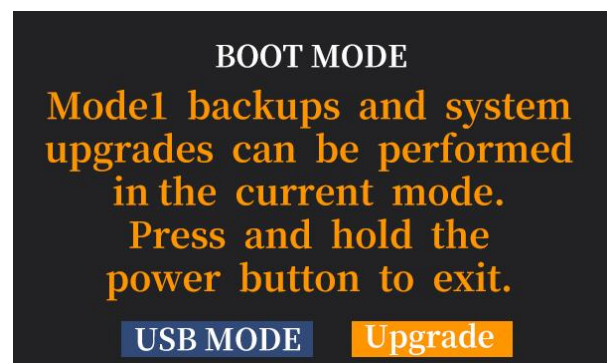

6) Upgrade firmware

>The following Upgrade MODE interface will appear on the screen, indicating that it has entered upgrade mode. Select "YES" and press the Push button to confirm.

>The transmitter starts to upgrade the firmware, and the percentage of the interface indicates the progress of the firmware upgrade.

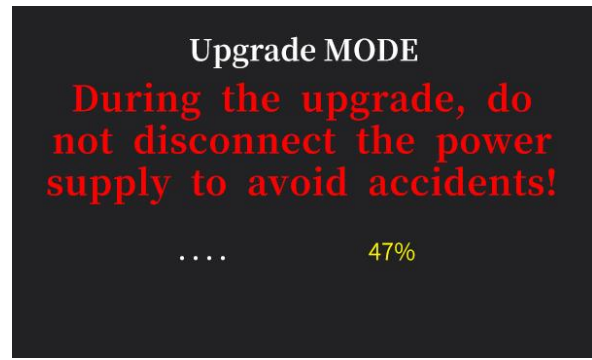
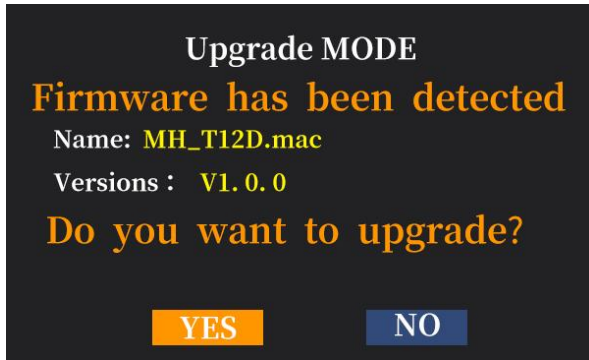

7) Firmware upgrade successful: When “Firmware upgrade successful” appears on the screen, the upgrade is successful.



8) Exit upgrade mode

>Short press the End button to exit upgrade mode.

>Long press the power button to use the transmitter normally. You can check the current firmware version in Transmitter Settings--ABOUT menu interface to confirm that the firmware upgrade is successful.

Technical Support Here

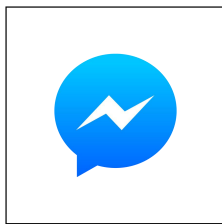

Contact RadioLink RL
via Facebook Messenger



T12D User Manual



T12D Tutorials

If the above communication cannot solve your problem, you can also send emails to our technical support: after_service@radiolink.com.cn This content is subject to change. Download the latest version from https://www.radiolink.com/t12d_manual

Thank you again for choosing RadioLink product.